



Clarion
MARINE
POWER SYSTEM

APX400.2M

**OPERATION
INSTALLATION
MANUAL**

INTRODUCTION

The Clarion APX400.2M is a full-featured two-channel amplifier incorporating the following features:

- Full frequency response with low distortion and exceptional signal to noise performance
- Advanced circuit design that features bridgeable and mixed mode operation for use in various systems, including those with satellite speakers and/or subwoofers
- Variable high-pass/low-pass electronic crossover with a 12dB per octave slope and full adjustable range (from 55Hz to 5.5kHz) to aid in audio system design
- Variable bass boost circuit to reinforce low frequency signals that may be lost due to subwoofer box design
- Adjustable input level controls with ground loop isolation accepting a wide range of input signals
- Remote turn-on with “soft start” muting to prevent turn-on “thump”
- Pulse-Width Modulated (PWM) MOSFET power supply with low AM RFI and protection circuits for overheating and speaker shorts
- 2-ohm load capability to drive a variety of speaker systems
- Gold-plated input/output connectors and an external automotive type fuse
- Aluminum heat sink for efficient heat dissipation
- Low profile, compact size for space limited installations

ABOUT THE MANUAL AND WARRANTY

To start enjoying your new Clarion two-channel amplifier, please read the instructions listed in this manual. Keep all instructions for future reference. Please fill out and send in the enclosed warranty card to protect your purchase and aid in warranty service. Also, **save your original sales receipt as proof of purchase.**

TABLE OF CONTENTS

| | |
|--------------------------------------|----|
| Description | 1 |
| Input Connections and Audio Controls | 1 |
| Connections for Power and Speakers | 3 |
| Applications | 4 |
| Installation | 7 |
| Mounting Precautions | 7 |
| Wiring Precautions | 7 |
| Setting the Gain | 10 |
| Setting the Crossover | 10 |
| Setting the Bass Boost | 10 |
| Final System Checks | 11 |
| Troubleshooting | 11 |
| Product Specs | 12 |
| Notes | 13 |

DESCRIPTION

The Clarion APX400.2M two-channel amplifier provides 2x70 watts of power into a 4 ohm load and 2x110 watts of power into a 2 ohm load. This full featured model is an excellent choice for a variety of marine audio sound system configurations.

The APX400.2M uses an unregulated MOSFET power supply for superior control of output wattage. A toroid-coil transformer yields maximum power transfer with minimum heat loss. Careful attention to circuit design keeps AM RFI at low levels, so you won't hear unwanted noise when the level is cranked up. Protection circuits safeguard the amplifier when overheating and speaker shorts or improper load conditions occur.

All connections and controls of the APX400.2M are on the end panels and are easy to understand. We use gold-plated RCA and barrier connectors to ensure the best electrical connection for your system. Included is an external automotive type fuse that is easy to replace.

INPUT CONNECTIONS AND AUDIO CONTROLS

The front panel of the APX400.2M contains connections for RCA Inputs, Speaker Level Inputs and Audio Controls as shown below.

The RCA Input Connections are gold-plated RCA Jacks and are labeled as RIGHT and LEFT.

Figure 1-

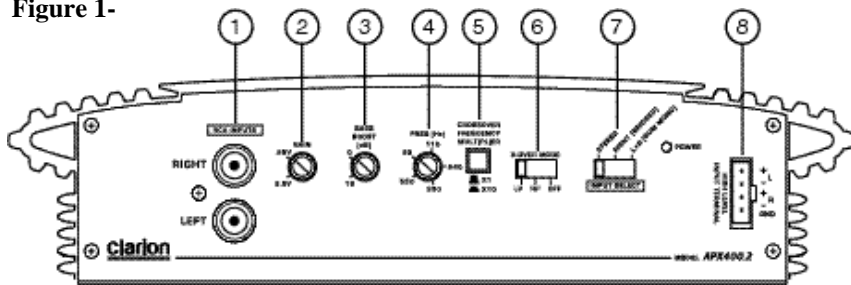

- | | |
|--------------------------------|--|
| 1. RCA Input Jacks | 5. Crossover Frequency Multiplier Switch |
| 2. Gain Control | 6. X-Over Mode Switch |
| 3. Bass Boost Control | 7. Input Select Switch |
| 4. Freq (Hz) Selection Control | 8. Speaker Level Inputs |

- **Gain Control** - This allows you to set the nominal operating level of the amplifier. The amplifier's range, 250mV to 2.5V for RCA inputs or 500mV to 5V for speaker level inputs, can accommodate input levels from virtually any brand of source unit.

- **Bass Boost Control**- The amplifier also features a "high-Q" (i.e. narrow frequency band) Bass Boost circuit. It acts much like an equalizer, with adjustable gain (from 0 to +18dB) fixed at 45Hz. Use this feature to tune low-frequency audio response to compensate for a less than ideal subwoofer enclosure design. The added boost produces rich, full bass tones that are normally difficult to reproduce in the car audio environment. NOTE: If Bass Boost is undesired, set Bass Boost to 0dB.

High-pass/Low-pass Filter Controls

- **Frequency (Hz) Selection Control** - The crossover frequency is fully adjustable between 55Hz and 5500Hz (via the Crossover Frequency Multiplier) for a wide range of crossover points. Use this feature, along with your speaker manufacturer's recommended crossover frequencies, to quickly design a more advanced system (see Applications on page 5.) NOTE: If the X-Over Mode Switch is set to OFF, varying the Freq (Hz) Control will produce no effect.

- **Crossover Frequency Multiplier Switch** - When engaged, this switch increases the crossover frequency by a factor of 10. Example: If the Freq (Hz) dial is set for 240 Hz, pushing in the Multiplier Switch changes the setting to 2400 Hz.

- **X-Over Mode Switch** - This switch is equipped with a 12dB per octave electronic filter for precise frequency attenuation with minimal phase distortion. The steep crossover slope keeps midrange tones out of the subwoofer and thereby eliminates an unnatural "nasal" tone quality in the audio system. A filter is activated by sliding the X-Over Mode Switch to either LP or HP.

- **Input Mode Switch** - This switch allows you to set the input mode. Stereo input allows full left and right stereo operation. Right (bridged) input allows single channel input for bridged operation. This is especially useful in high-powered systems when using one amplifier for each subwoofer/speaker. L + R (sum mono) allows a stereo input to be summed into a mono output.

- **Speaker Level Inputs** - These provide connections for a high-level stereo source. In addition, these connections are provided for installations where the source unit's RCA outputs are unavailable.

WARNING: When using the speaker (high-level) inputs, the Black wire must be grounded at the Radio. Failure to do this will result in noise and improper operation.

CONNECTIONS FOR POWER AND SPEAKERS

The rear panel of the APX400.2M contains power and speaker connections as shown below.

Figure 2-

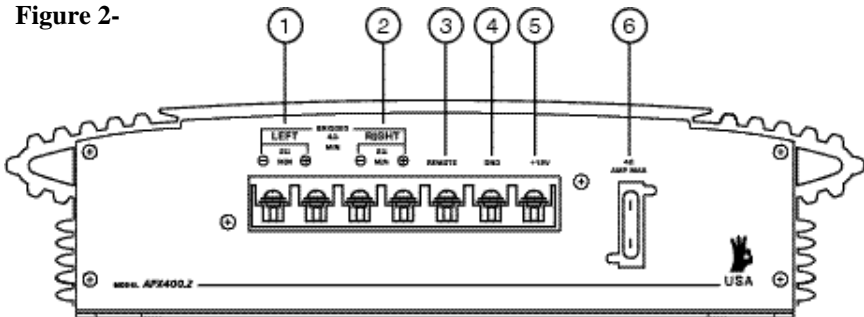

- | | |
|-------------------------|------------------------|
| 1. Left Speaker Output | 4. Ground Input |
| 2. Right Speaker Output | 5. Battery + 12V Input |
| 3. Remote Turn-on Input | 6. 25 Amp Fuse |

APPLICATIONS

The Clarion APX400.2M 2-channel marine audio amplifier can be used in a variety of system applications. Here are some examples to help plan your own installation.

Bridged- Mono Subwoofer System

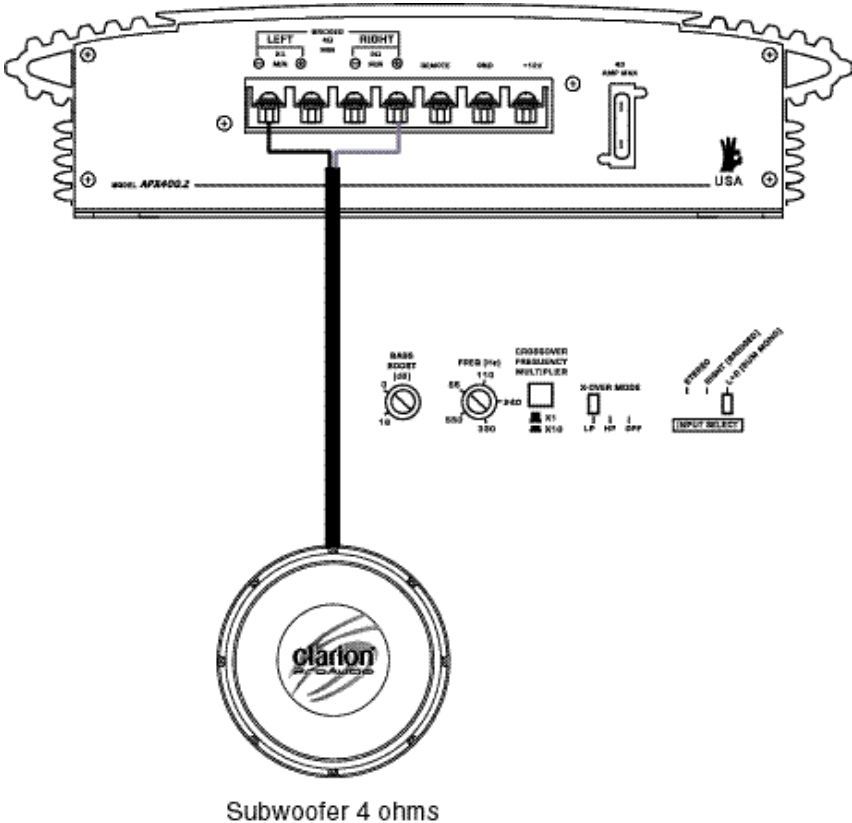

Set X-Over Mode to LP and adjust
FREQ to speaker specifications.

Figure 3 - In this application the amplifier is bridged for mono operation to drive a subwoofer.

2-Channel Full-Range, Satellite, or Subwoofer Stereo System
 (Set INPUT SELECT Switch to STEREO)

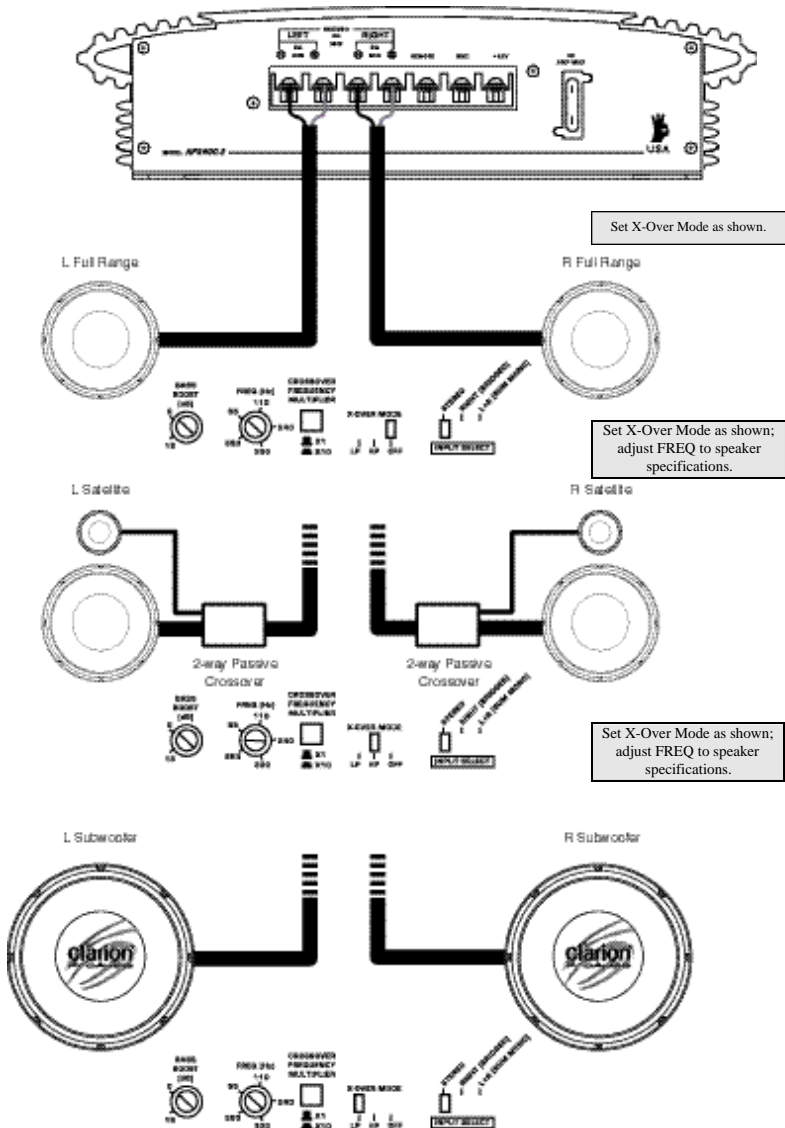
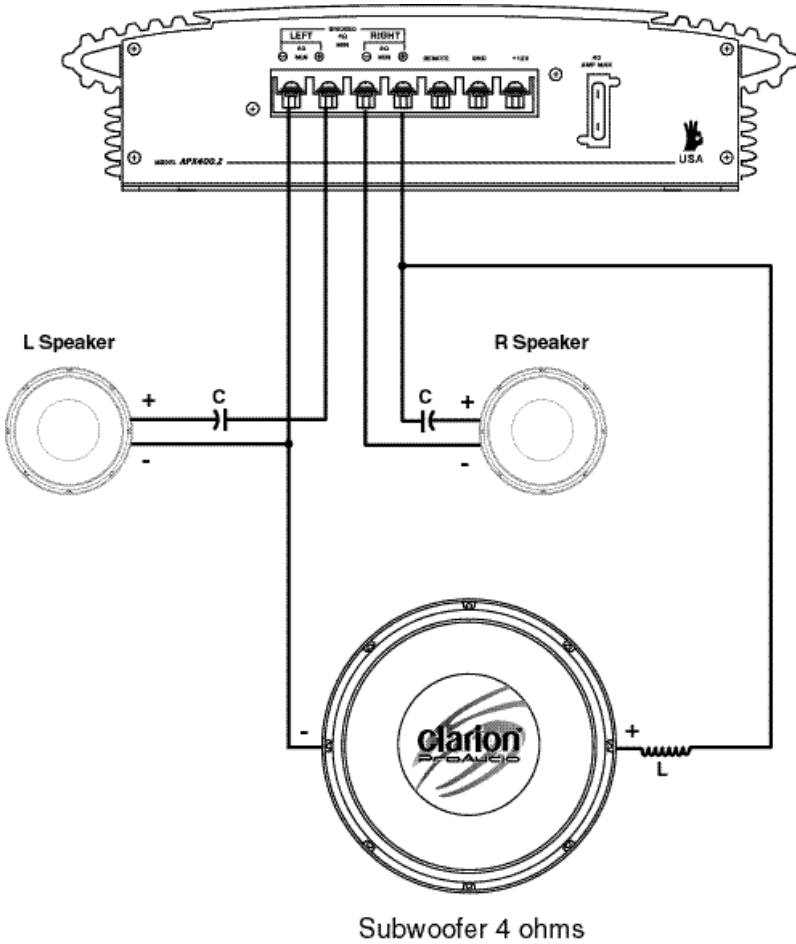

Figure 4 - In this application, the amplifier is used in stereo and drives two full-range (or satellite or subwoofer) speakers. NOTE: A passive crossover must be used with satellite speakers.

APPLICATIONS

Mixed-Mode Satellite and Subwoofer System

(Set INPUT SELECT Switch to STEREO)



| FREQ (hz) | L (mH) | C (uF) |
|-----------|--------|--------|
| 80 | 8.0 | 497 |
| 100 | 6.4 | 398 |
| 125 | 5.1 | 318 |
| 150 | 4.2 | 265 |
| 200 | 3.2 | 199 |

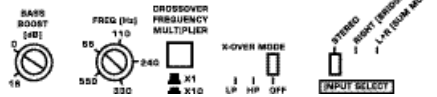

Set X-Over Mode to OFF.

NOTE: Chart values based on 4 ohm speakers.

Figure 5 - The amplifier can be configured for a mixed-mode operation. The table provides component values to create a 6dB per octave crossover at specified frequencies. Use components that have a $\pm 5\%$ tolerance and capacitors rated at 100V. **NOTE:** Choose the same frequency for both LP and HP crossovers. Do not overlap frequencies, as this may damage the amplifier.

INSTALLATION

This section lists Mounting and Wiring Precautions for installing a Clarion APX400.2M marine amplifier. Combined with the experience of a professional installer, these safeguards provide enough detail to successfully complete an installation. If you do not have the necessary skills, do not install the amplifier yourself. Instead, see your authorized Clarion dealer for installation recommendations.

MOUNTING PRECAUTIONS

Although the Clarion APX400.2M incorporates heat sinks and protection circuits, mounting the amplifier in a tight space without any air movement can still damage internal circuitry over time. Choose a site that provides adequate ventilation and is isolated from the marine environment. For easy system set-up, mount the amplifier so the front panel controls will be accessible after installation.

In addition, observe the following precautions:

1. For the most efficient cooling, mount the amplifier so cool air runs along the length of the fins rather than across them. Remember, any moving air will dissipate heat.
2. Mount the amplifier on a rigid surface. Avoid mounting to subwoofer enclosures or areas prone to vibration.
3. Prior to drilling, make sure proposed mounting holes will not cut into the fuel tank, fuel lines, or electrical wiring.

WIRING PRECAUTIONS

Read all wiring precautions. If you are not sure of the connections, contact your authorized Clarion dealer.

1. Before installation, make sure the source unit Power switch is in the OFF position.
2. Disconnect the negative (-) lead of the battery before making any power connections.
3. When making connections, be sure that each connection is clean and secure. Insulate final connections with electrical tape or shrink tubing. Failure to do so may damage your equipment.
4. A secure clean ground connection is critical to the performance of your Clarion amplifier. Use the shortest ground wire possible and securely connect to the vessel battery to minimize resistance and avoid noise problems.

5. Add an external fuse on the amplifier's positive (+) power lead and connect it as close as possible to the vessel's (+) battery terminal. Use a rating that equals the total current consumption at full output of all amplifiers in the system. Adding an external fuse will protect the electrical system from short circuits that can cause a fire.
6. Refer to Figure 6 when making electrical connections. Connect the amplifier's positive (+) lead via a fuse directly to the positive (+) terminal on the battery. Do not connect this wire to the vessel's fuse panel. Use red-insulated 10-gauge (or larger) wire for the amplifier's positive (+) power lead and the same-gauge black-insulated wire for the ground.
7. When replacing the amplifier's fuse, always use one having the same current rating. Substituting a higher-rated fuse or a slow-blow type can result in serious damage to the amplifier.
8. Make sure that your vessel's electrical system (alternator, battery, etc.) is capable of handling the additional load. If you are planning a multi-amplifier system, you may need to add a second battery and possibly upgrade the alternator with a higher-output rated model. Consult your authorized Clarion dealer for recommendations.
9. To avoid noise problems, run the amplifier's positive (+) power lead along one side of the vessel to the battery. Run the remote turn-on wire and RCA audio cables down the center, and route the speaker wires along the remaining side. If wires must cross, run them perpendicular to each other.
10. When creating passage holes for the power wire, use grommets to eliminate any sharp edges created during drilling. This will protect the wire from being nicked and causing a short circuit.
11. Extra cable can cause signal loss and act as an "antenna" for noise. Use only high-quality RCA cables that are no longer than necessary to make a direct connection with the source unit or equalizer.

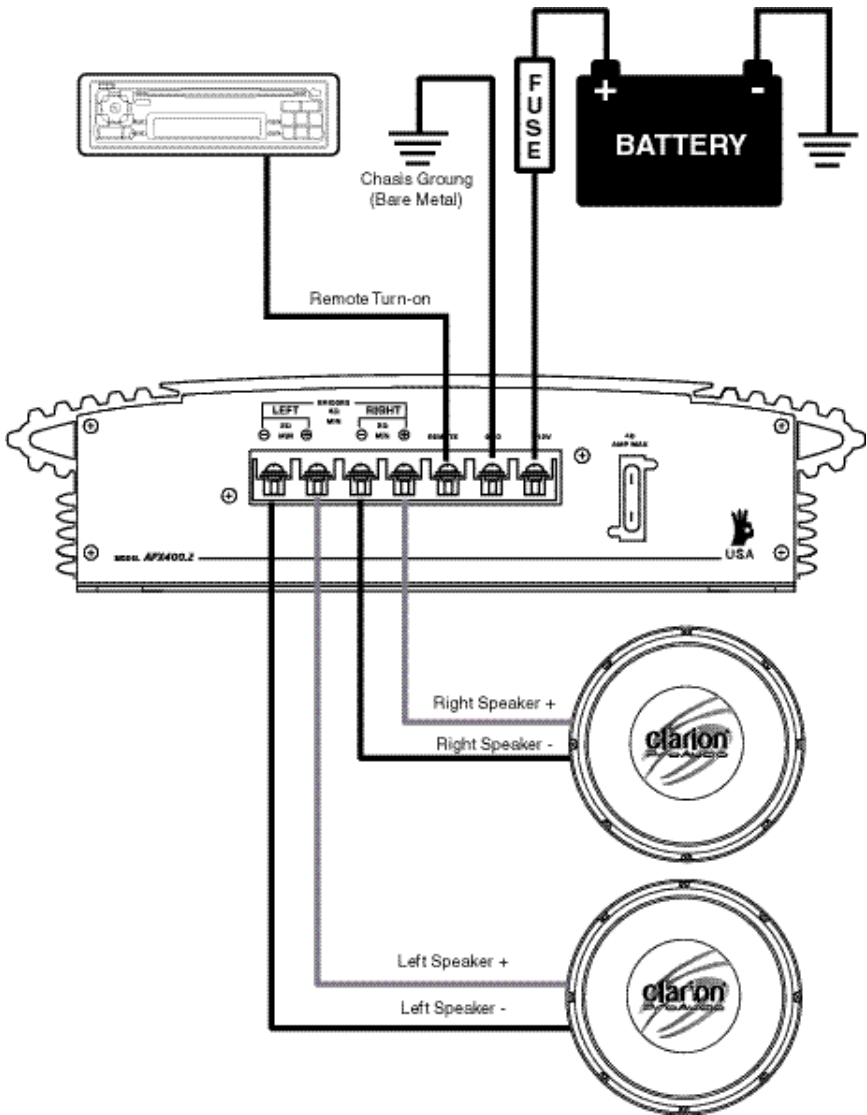

Figure 6. - Electrical connections for the APX400.2M.

SETTING THE GAIN

After completing the installation, follow these steps to set the Gain Control and then perform the Final System Checks.

1. Turn the Gain Control all the way counter-clockwise.
2. Turn the vessel's Ignition Switch to the ON position. Then turn the ON/OFF Switch on the source units to the ON position. Set all Tone or Equalization Controls to "flat" positions and turn Loudness off.
3. Play a CD or Tape and set the Volume Control at 75% of full level.
NOTE: If the system uses an equalizer, set its frequency controls to "flat" positions.
4. Slowly increase the Gain Control. Stop when you hear a slight distortion of audio.

SETTING THE CROSSOVER

The Clarion APX400.2M features a fully adjustable crossover. To set the crossover, follow these steps.

1. Using the X-Over Mode Switch, select the desired mode - LP for Low Pass, HP for High Pass and OFF for Full Range.
2. Using the Freq (Hz) Control, select the desired frequency. If the desired frequency exceeds the range of the Freq (Hz) Control, press the Crossover Frequency Multiplier Switch to increase the value by a multiplier of 10.
•For example, $55\text{Hz} \times 10 = 550\text{Hz}$ or $550\text{Hz} \times 10 = 5.5\text{kHz}$.

SETTING THE BASS BOOST

1. Initially set the Bass Boost control to its full left position (i.e. 0dB).
2. Listen to a variety of music styles (e.g. Rock, Rap, etc.) and slowly increase the Bass Boost control until a noticeable increase in low bass response is perceived.
3. Slowly adjust the Bass Boost control (up or down) to realize the best bass response.

CAUTION: If you hear a "pop" (due to speaker over-excursion), lower the Bass Boost to prevent speaker damage. If the system sounds muddy and distorted (due to amplifier clipping), lower Bass Boost to avoid shutdown from overheating.

FINAL SYSTEM CHECKS

1. Start the engine and turn on the source unit. After a two-second delay, slowly increase the Volume Control and listen to the audio. If you hear any noise, static, distortion or no sound at all, check the connections, and also refer to Troubleshooting. Depending on your system design, the levels may become quite loud even at low Volume Control settings. Until you get an “audio feel” of the system’s power, use care when adjusting controls.
2. Turn the Balance Controls to their extreme positions and listen to the results. Audio imaging should match control settings (audio from the left speaker when balance is left).
3. Increase the volume and verify that the amplifier reproduces audio (at full frequencies) without distortion. If you hear distortion, check the connections and verify that the Gain Control is set correctly. Another possibility is damaged speakers or under-powered speakers. Once again refer to Troubleshooting for additional help.

TROUBLESHOOTING**Problem**

No Audio.

Solution

Low or no remote turn-on voltage. Check remote connections at amplifier and source unit.

Blown amplifier fuse. Replace with new fast-blow fuse (same rating).

Power wires not connected. Check battery and ground wiring at amplifier; also check battery connections.

Speaker leads shorted. Check speaker continuity to ground, it should not show a common ground.

Speakers not connected or are blown. Check speaker connections at amplifier, measure coil impedance.

Problem

Audio cycles on and off.

Solution

Thermal protection circuits are shutting amplifier off. Check location for adequate ventilation; consult an authorized Clarion Audio Dealer.

Problem

Distorted audio.

Solution

Gain is not set properly, or damaged speaker cones. Review Setting Gain; inspect each speaker cone for signs of damage (i.e. frozen cone, burning smell, etc.)

Problem

Audio lacks punch.

Solution

Speakers wired incorrectly, which causes cancellation of bass frequencies. Check polarity of wires from amplifier to each speaker as defined by the system design.

Problem

Amplifier fuse keeps blowing.

Solution

Incorrect wiring or short circuit. Review Installation and check all wiring connections.

Problem

Whining or ticking noise in the audio with engine on.

Solution

Amplifier is picking up alternator noise or radiated noise. Turn down input gain; move audio cables away from power wires. Check power and ground connections on amplifier; install an in-line noise filter on source unit's power wire; check alternator and/or voltage regulator; test for weak battery or add water to battery

PRODUCT SPECS

APX400.2M

| | |
|---|----------------------------|
| Frequency Response | 20Hz ~ 20kHz |
| Signal Noise Ratio | >98db |
| THD | .05% all channels driven |
| Input Sensitivity Low Level | 250mV ~ 2.5 V |
| Input Sensitivity Speaker Level | 500mV ~ 5V |
| Max. Power Output | 380w (190 x 2) |
| Cont. Power Output | 200w (100w x 2) @ .08% THD |
| 2-Ohm Stereo Output | 190 x 2 @ .05% THD |
| Bridged Power | 280 x 1 @ .05% THD |
| Dimensions | 2 1/8"H x 8 1/4"W x 12" L |
| Current Consumption at output @ max power | 43A @ 382 Watts |

NOTES

NOTES



661 W. Redondo Beach Blvd.
Gardena, CA 90247
1-800-GO-CLARION
www.clarion-usa.com